

Applicable Model

R20K

Drawing Title

Intercom Panel

Drawing Unit

mm

Drawing Scale

Not to scale

**DRAFT
SUBJECT TO
CHANGE**

Last Revised

Oct 09,2023

Drawing Version

V1.0

Page

1 of 10

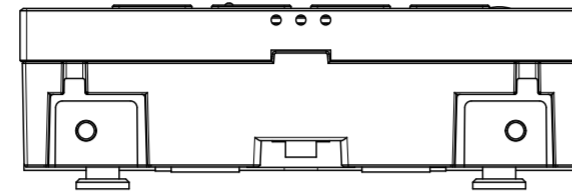

⑤ TOP VIEW

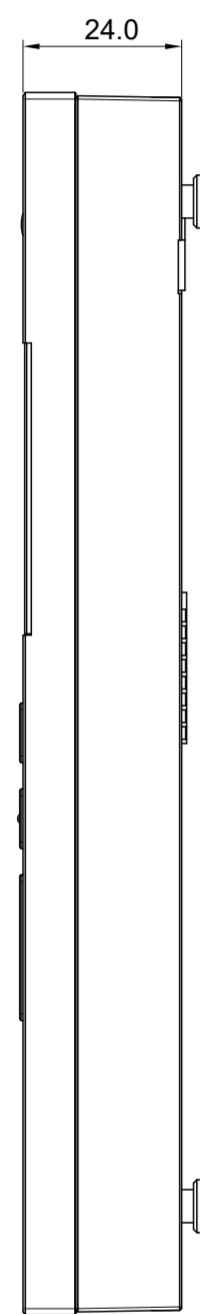

② RIGHT VIEW

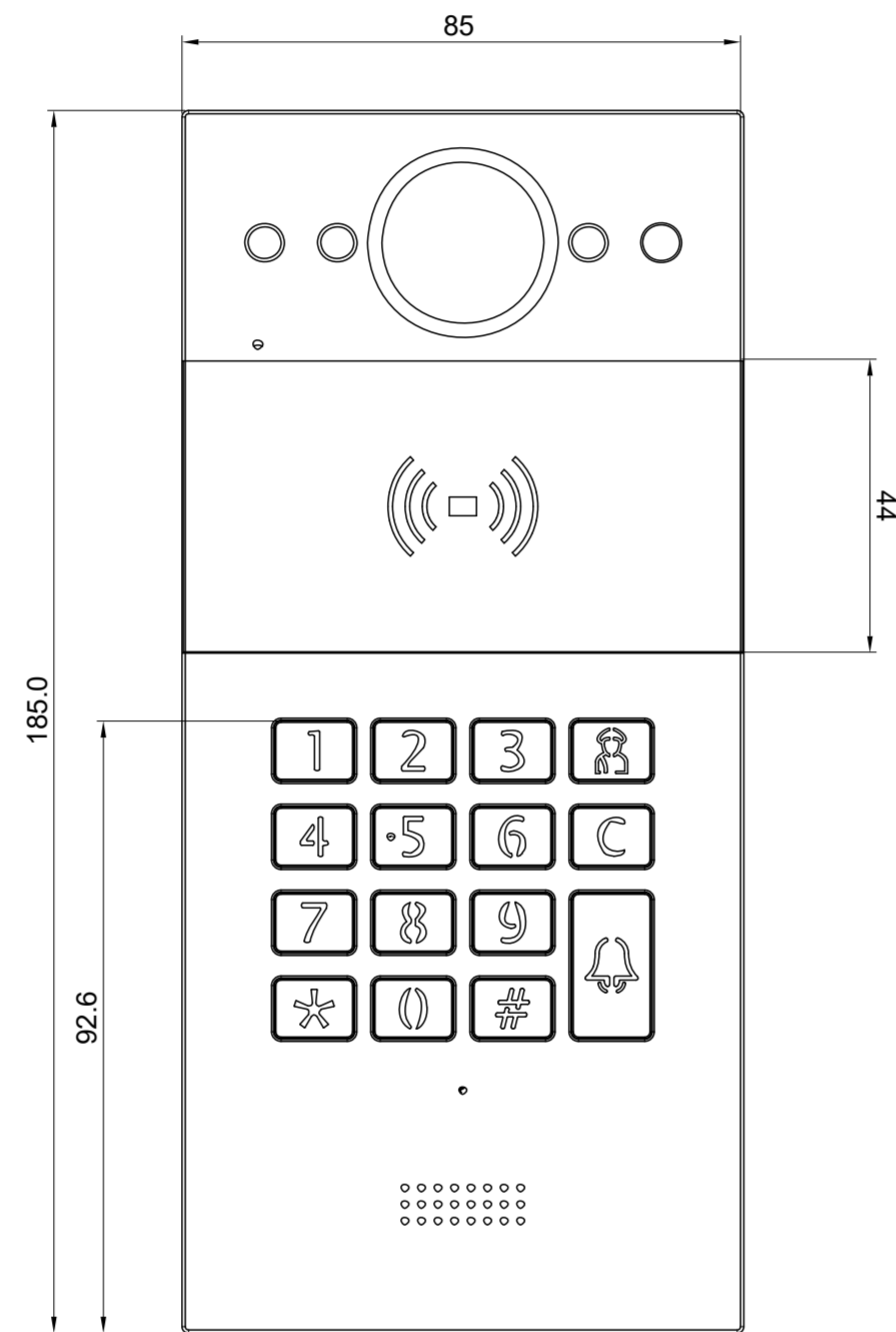

① FRONT VIEW

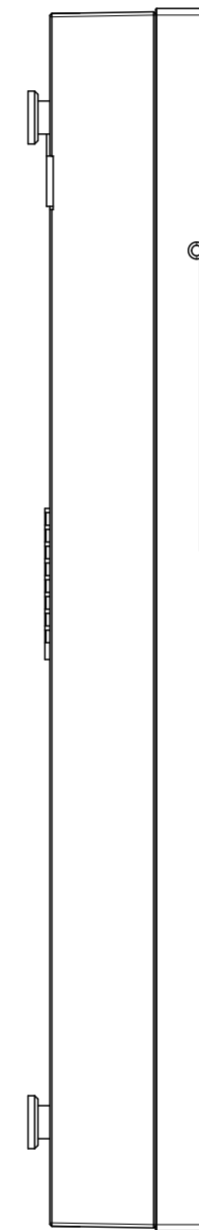

③ LEFT VIEW

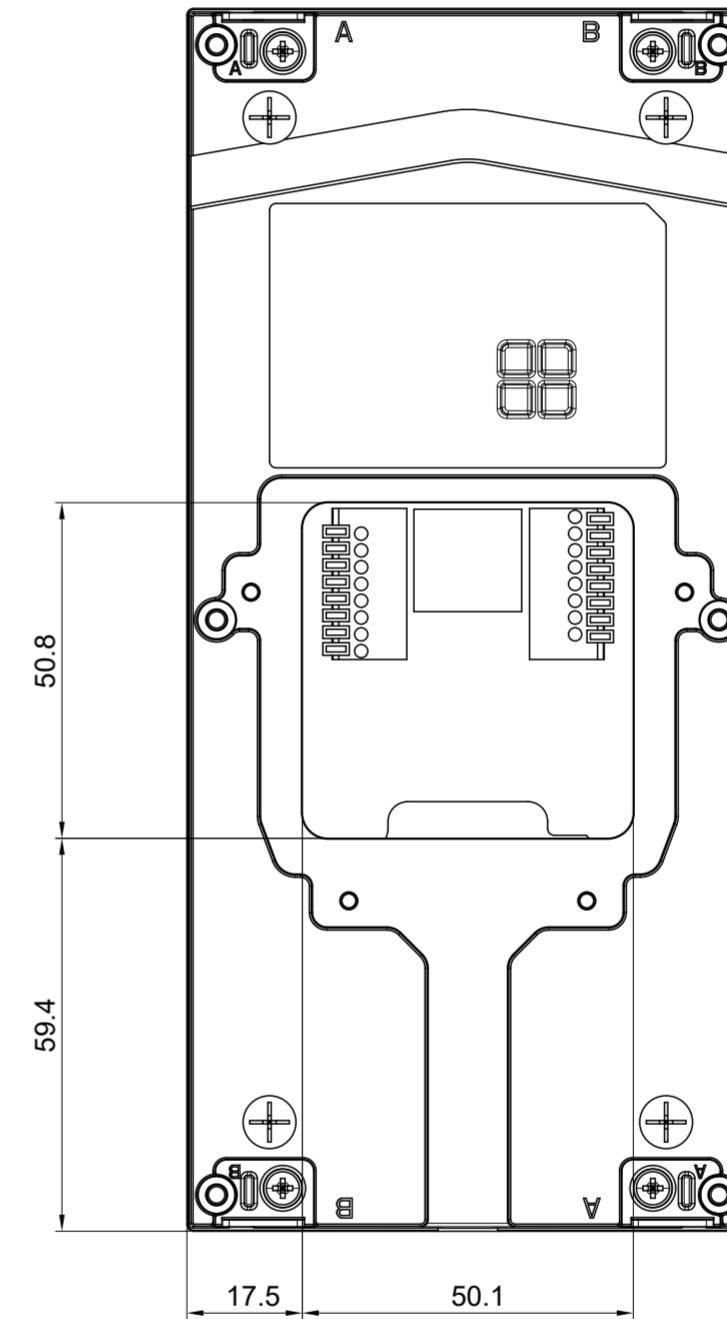

④ BACK VIEW

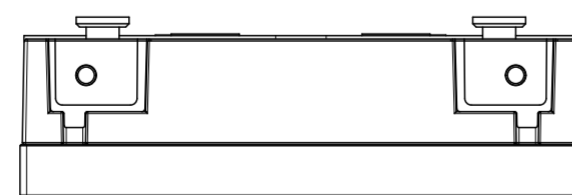

⑥ BOTTOM VIEW

Applicable Model

R20K

Drawing Title

Wall Mounting Bracket

Drawing Unit

mm

Drawing Scale

Not to scale

**DRAFT
SUBJECT TO
CHANGE**

Last Revised

Oct 09, 2023

Drawing Version

V1.0

Page

2 of 10

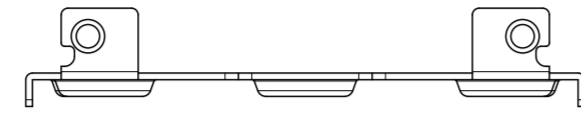

⑤ TOP VIEW

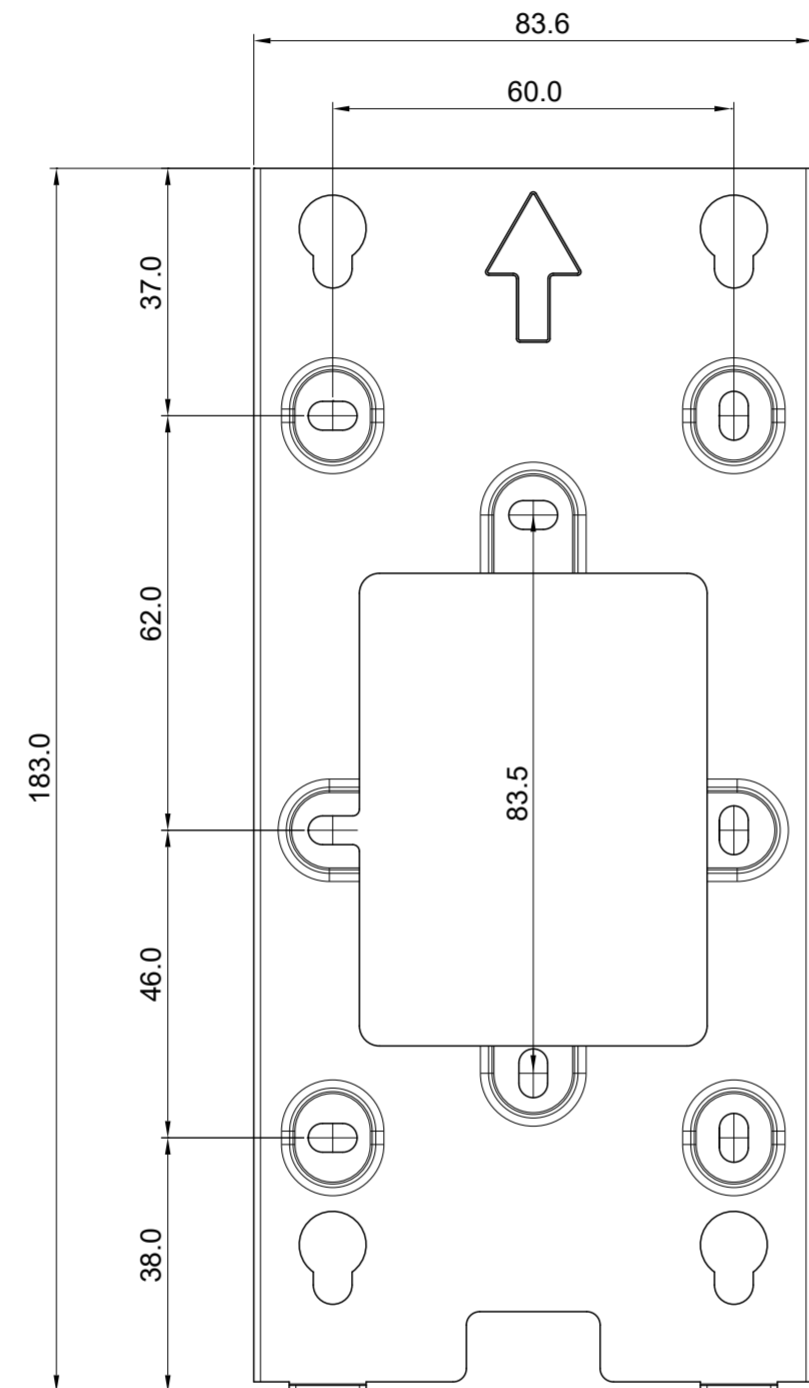

① FRONT VIEW

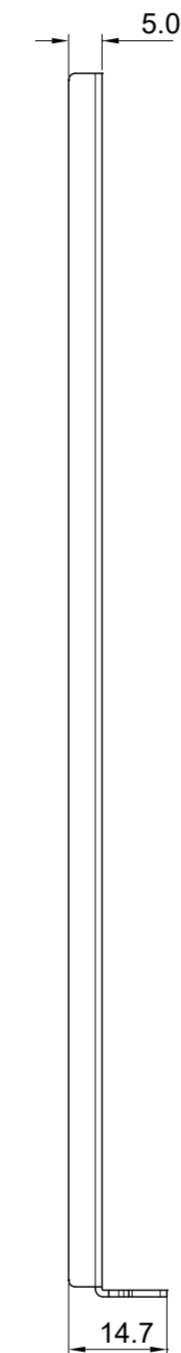

③ LEFT VIEW

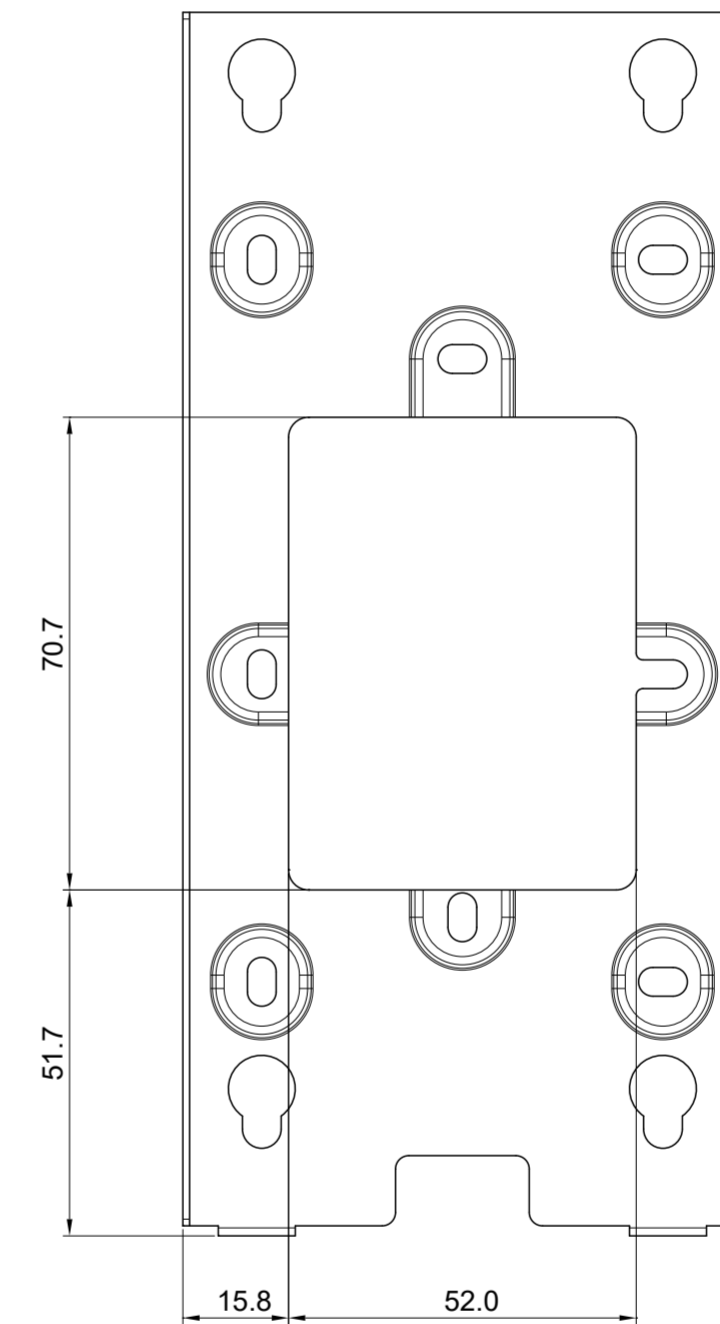

④ BACK VIEW

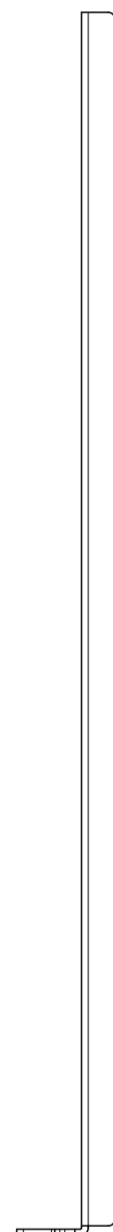

② RIGHT VIEW

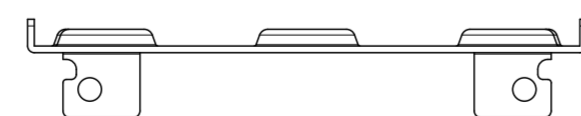

⑥ BOTTOM VIEW

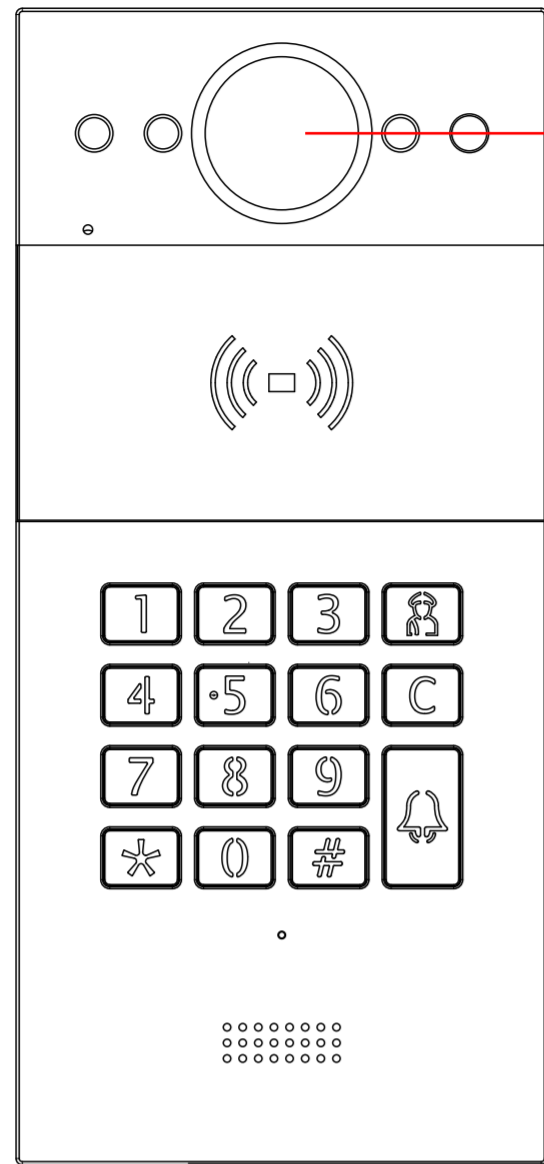

① INTERCOM PANEL FRONT VIEW

1235mm TO BOTTOM OF PANEL

1400mm TO CENTER OF CAMERA

ADA Compliance Requirement

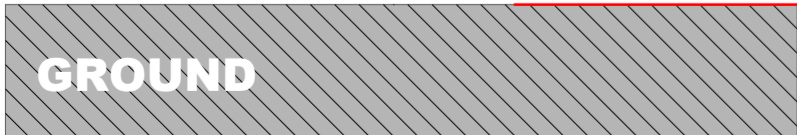

GROUND

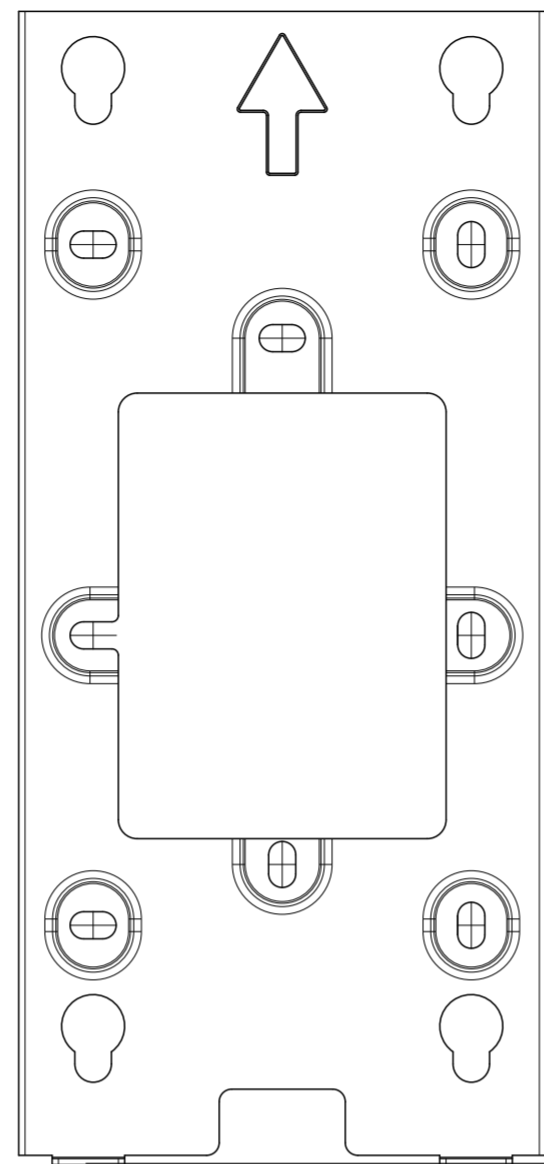

② FRONT VIEW:WALL MOUNTING BRACKET PLACEMENT

1235mm TO BOTTOM OF BRACKET

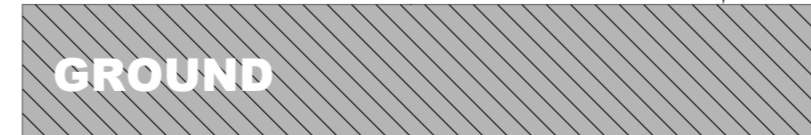

GROUND

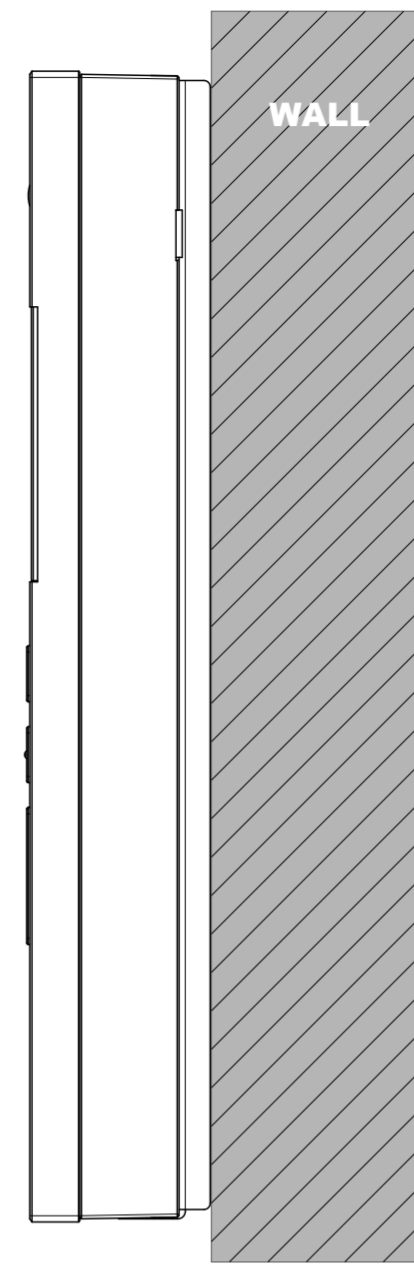

③ SIDE VIEW:INTERCOM PANEL ON WALL

Applicable Model

R20K

Drawing Title

Placement

Drawing Unit

mm

Drawing Scale

Not to scale

**DRAFT
SUBJECT TO
CHANGE**

Last Revised

Oct 09,2023

Drawing Version

V1.0

Page

3 of 10

Applicable Model

R20K

Drawing Title

On-Wall Mounting
Rain Cover

Drawing Unit

mm

Drawing Scale

Not to scale

**DRAFT
SUBJECT TO
CHANGE**

Last Revised

Oct 09,2023

Drawing Version

V1.0

Page

4 of 10

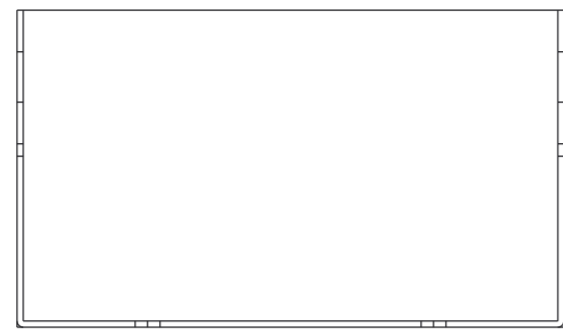

⑥ **BOTTOM VIEW**

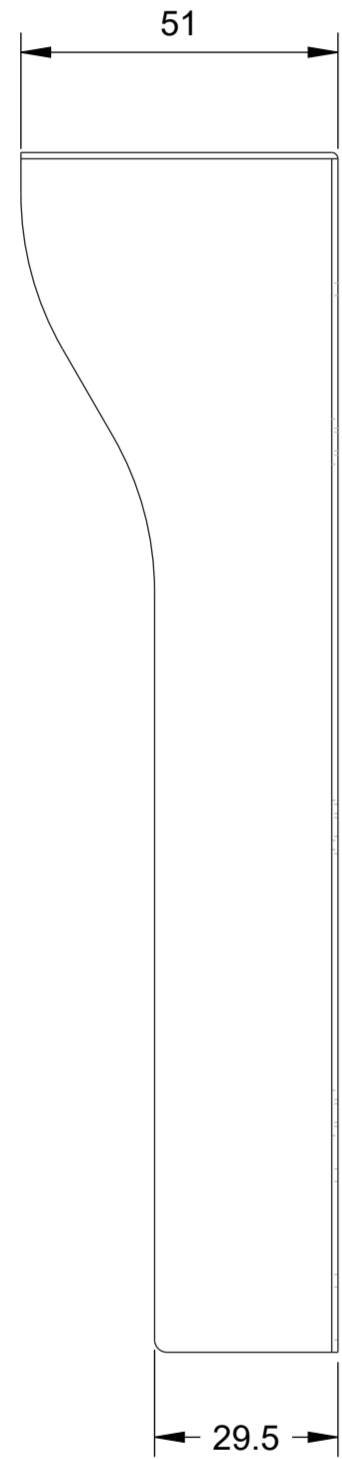

② **RIGHT VIEW**

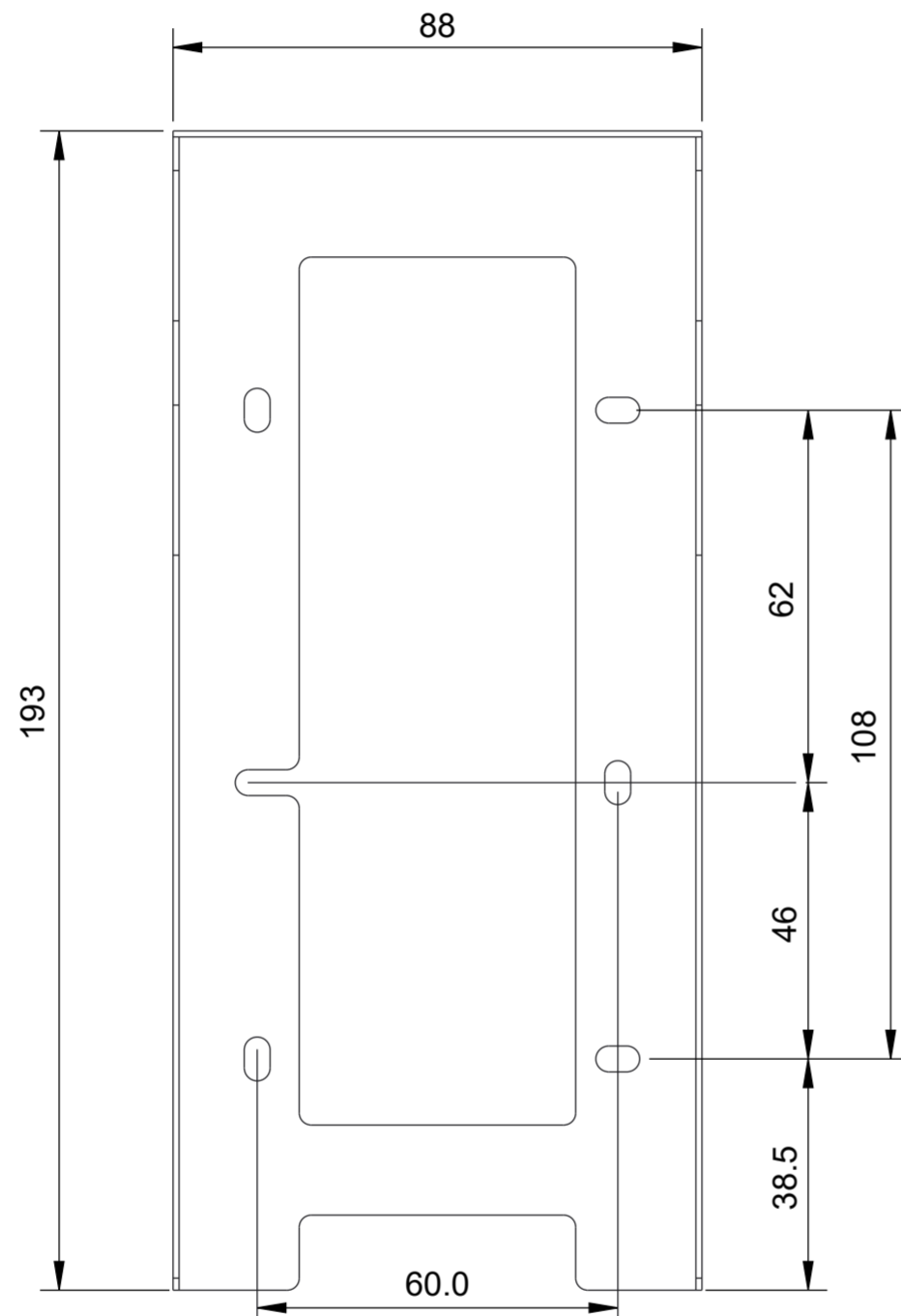

① **FRONT VIEW**

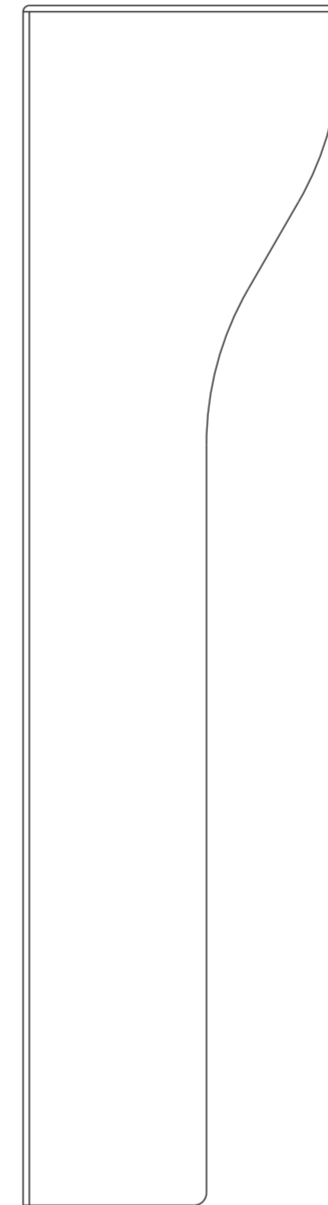

③ **LEFT VIEW**

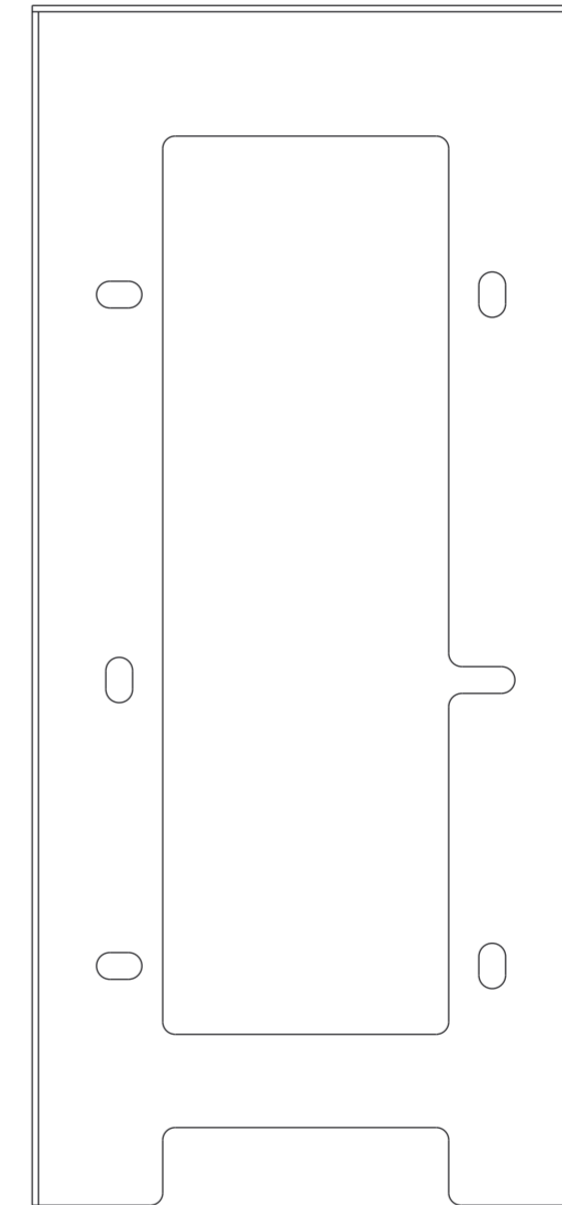

④ **BACK VIEW**

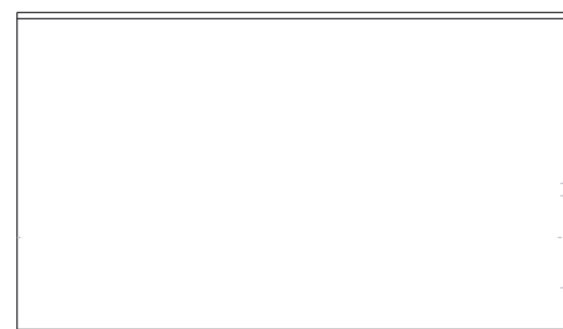

⑤ **TOP VIEW**

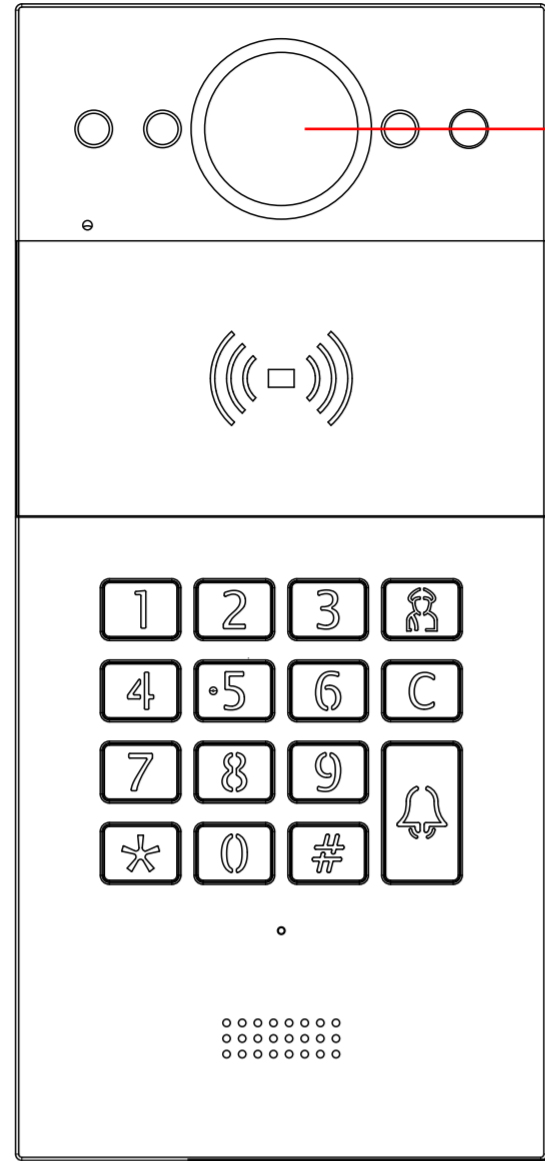

① INTERCOM PANEL FRONT VIEW

1235mm TO BOTTOM OF PANEL

1400mm TO CENTER OF CAMERA

ADA Compliance Requirement

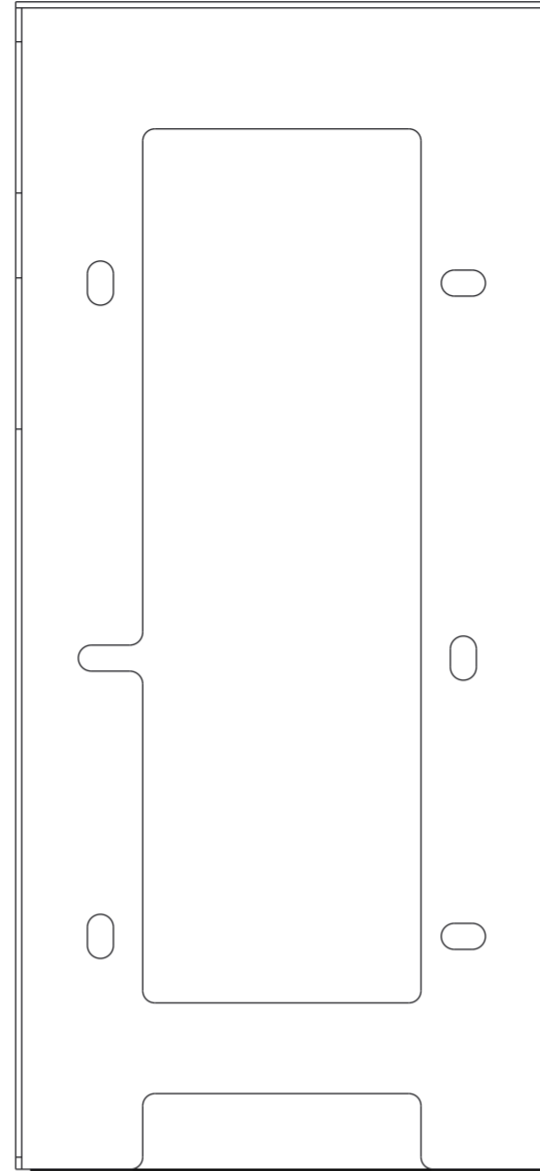
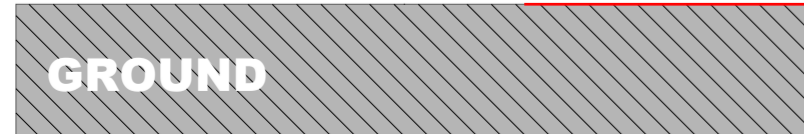

② FRONT VIEW:WALL MOUNTING BRACKET PLACEMENT

1235mm TO BOTTOM OF BRACKET

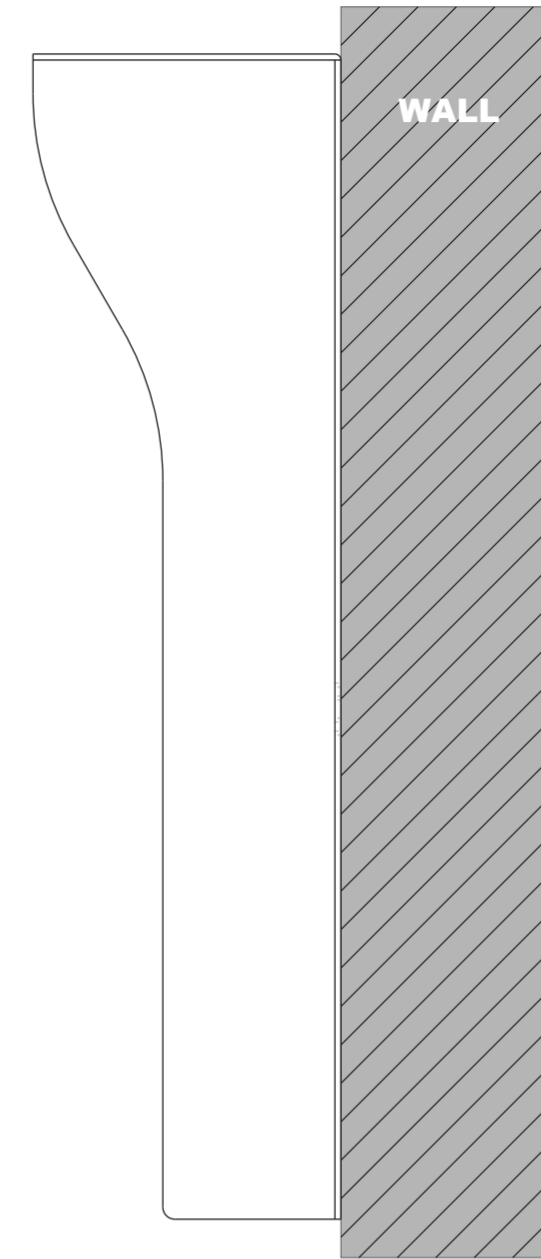
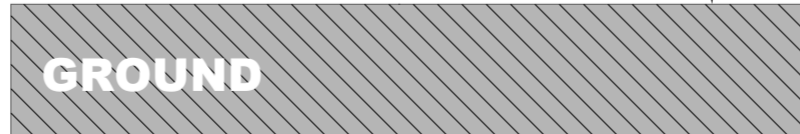

③ SIDE VIEW:INTERCOM PANEL ON WALL

Applicable Model

R20K

Drawing Title

Placement

Drawing Unit

mm

Drawing Scale

Not to scale

**DRAFT
SUBJECT TO
CHANGE**

Last Revised

Oct 09,2023

Drawing Version

V1.0

Page

5 of 10

Applicable Model

R20K

Drawing Title

Decorative Panel

Drawing Unit

mm

Drawing Scale

Not to scale

**DRAFT
SUBJECT TO
CHANGE**

Last Revised

Oct 09,2023

Drawing Version

V1.0

Page

6 of 10

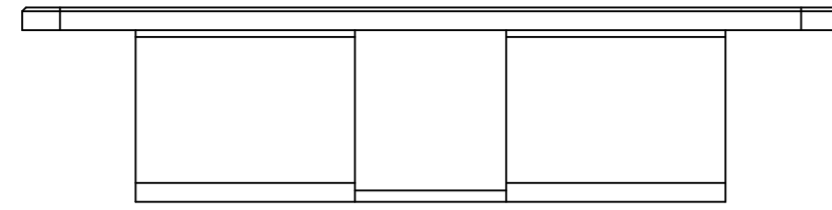

⑤ TOP VIEW

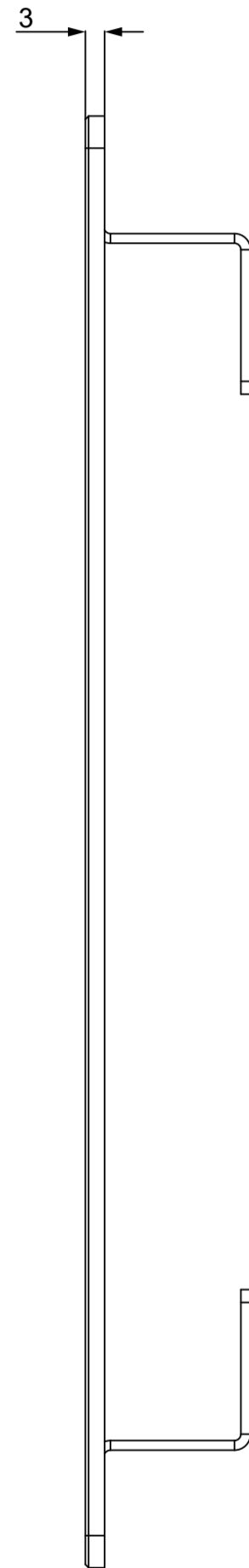

② RIGHT VIEW

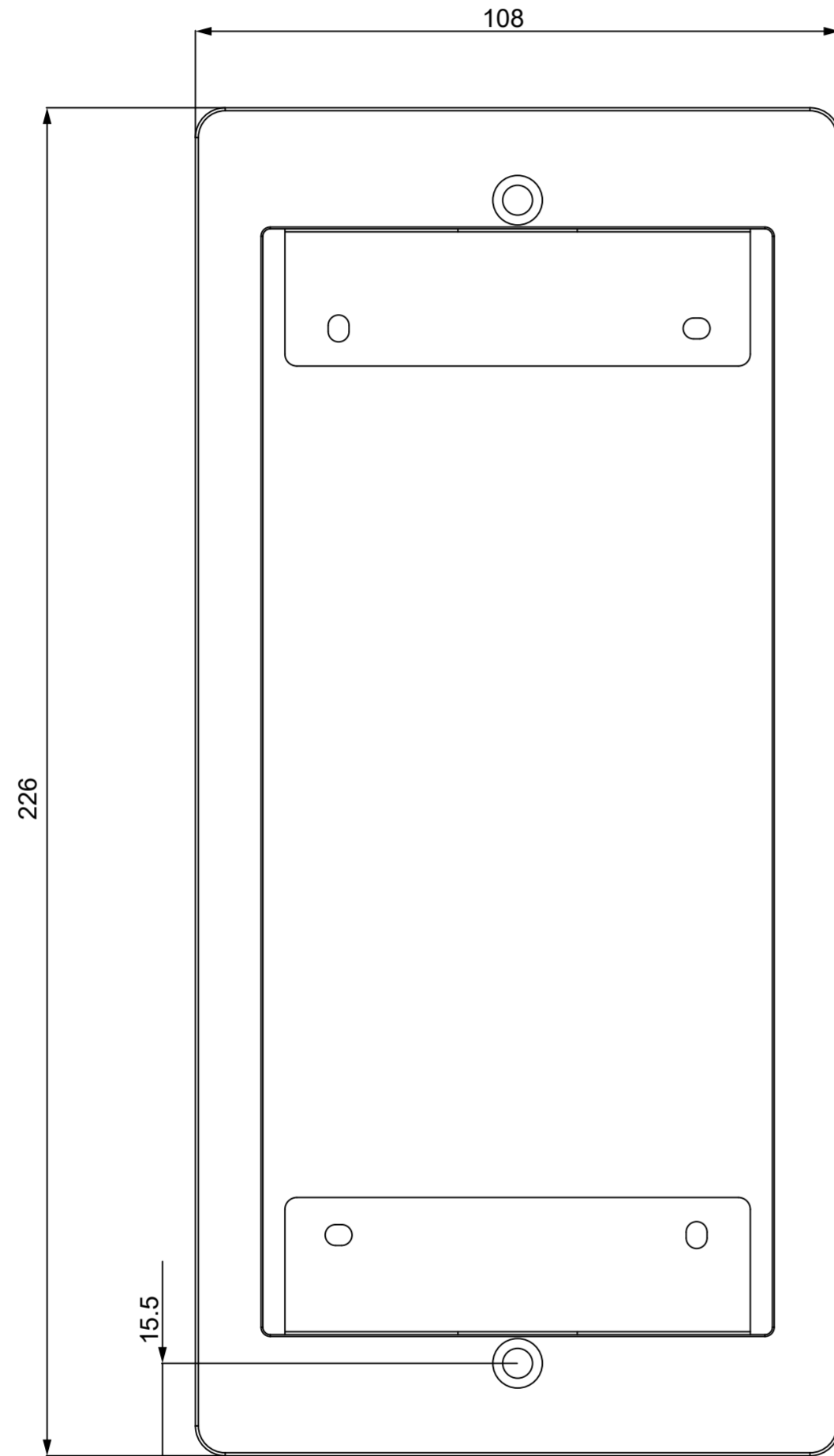

① FRONT VIEW

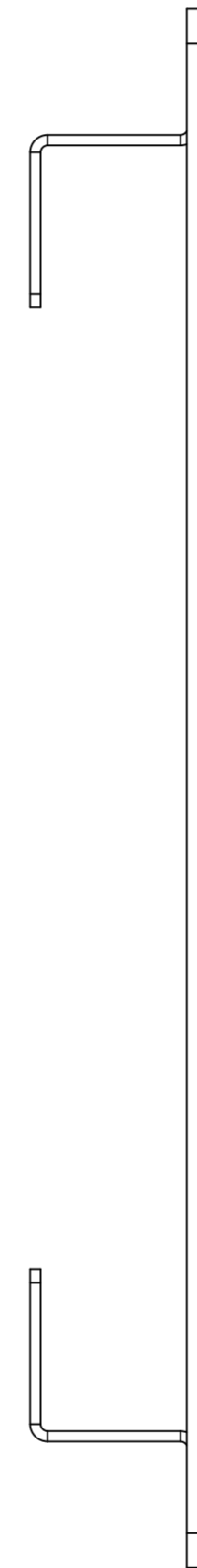

③ LEFT VIEW

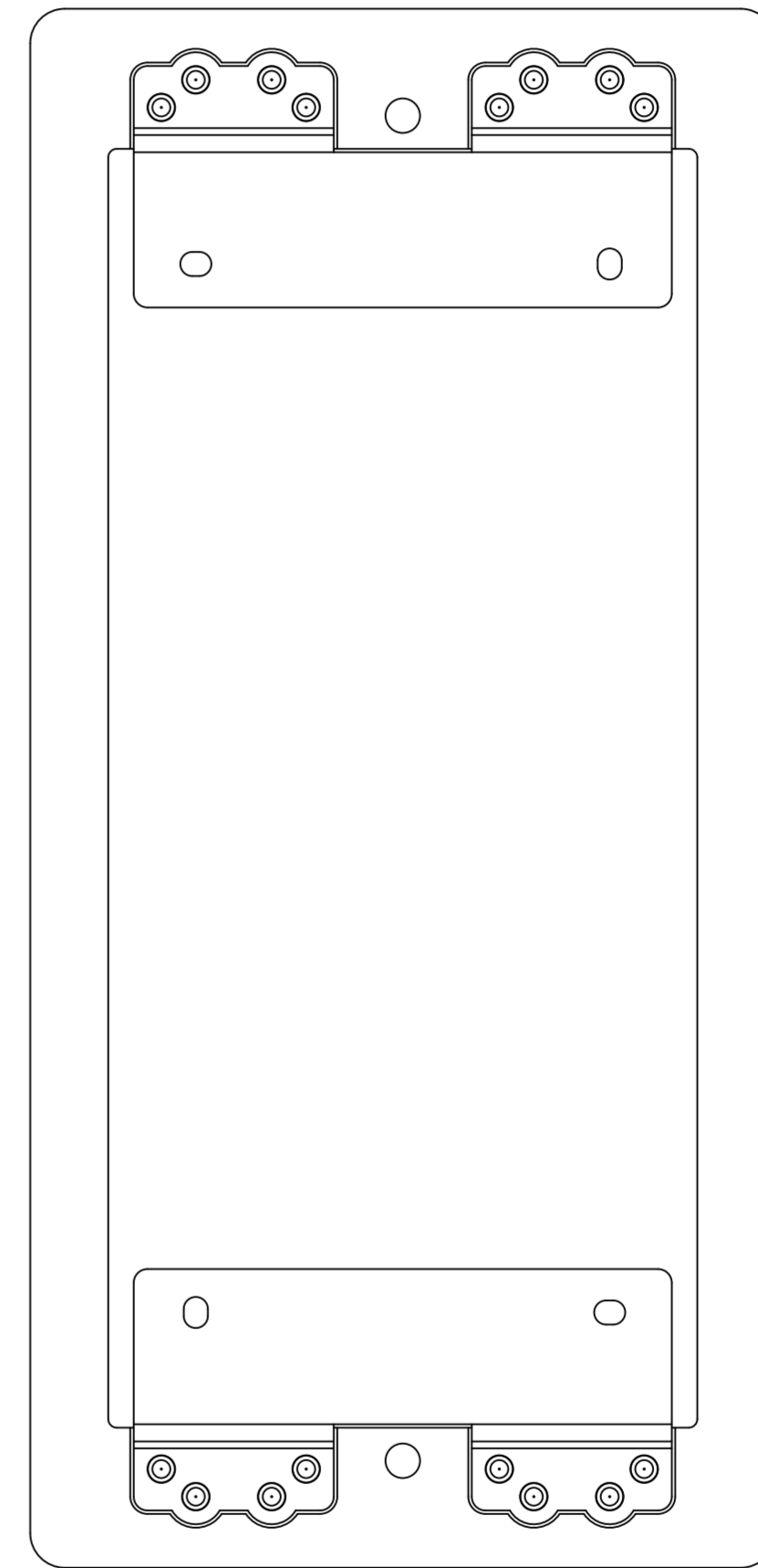

④ BACK VIEW

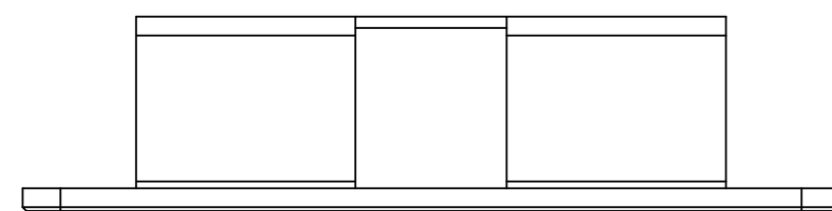

⑥ BOTTOM VIEW

Applicable Model

R20B

Drawing Title

Flush Mounting Box

Drawing Unit

mm

Drawing Scale

Not to scale

**DRAFT
SUBJECT TO
CHANGE**

Last Revised

Oct 09,2023

Drawing Version

V1.0

Page

7 of 10

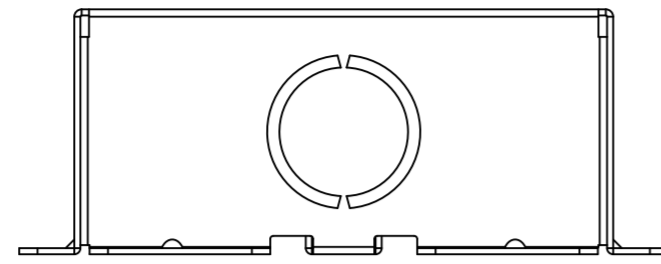

⑥ **BOTTOM VIEW**

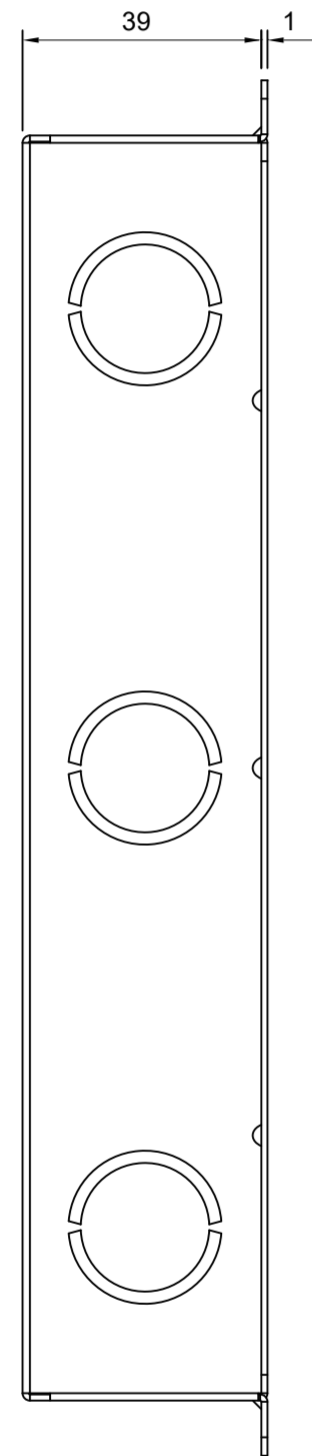

② **RIGHT VIEW**

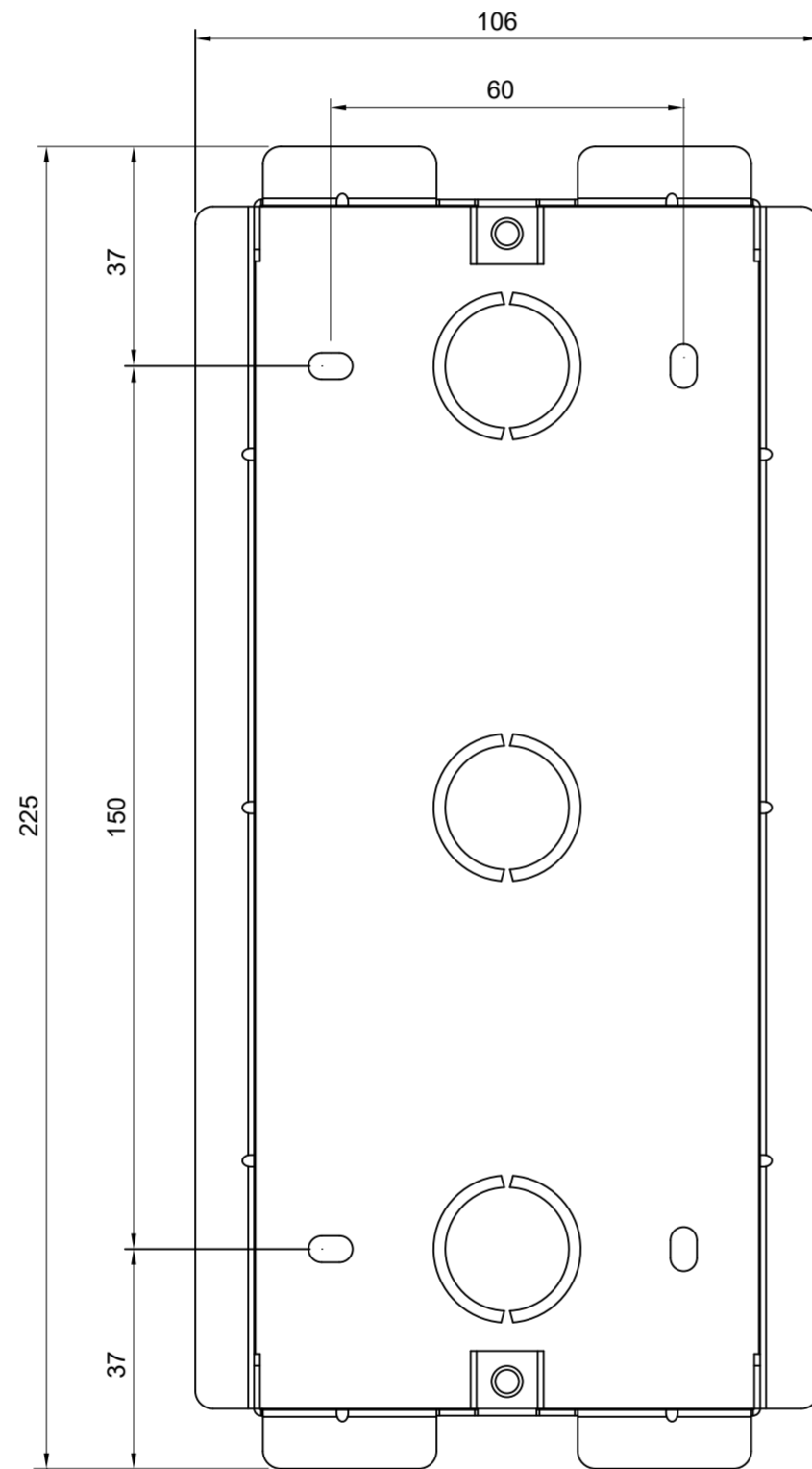

① **FRONT VIEW**

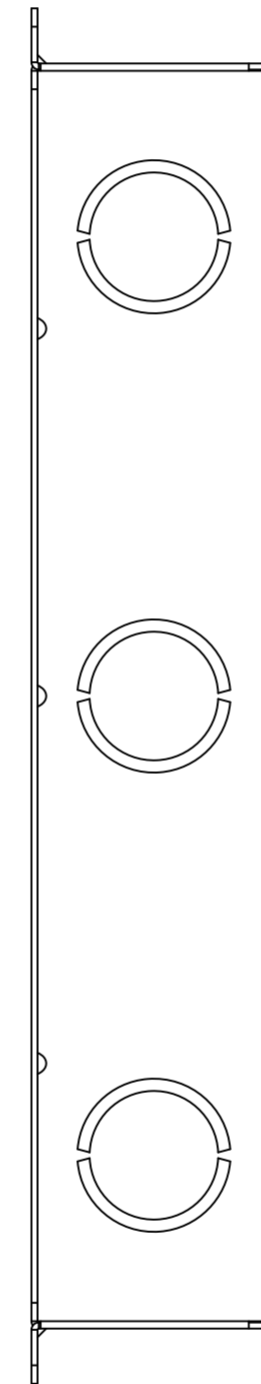

③ **LEFT VIEW**

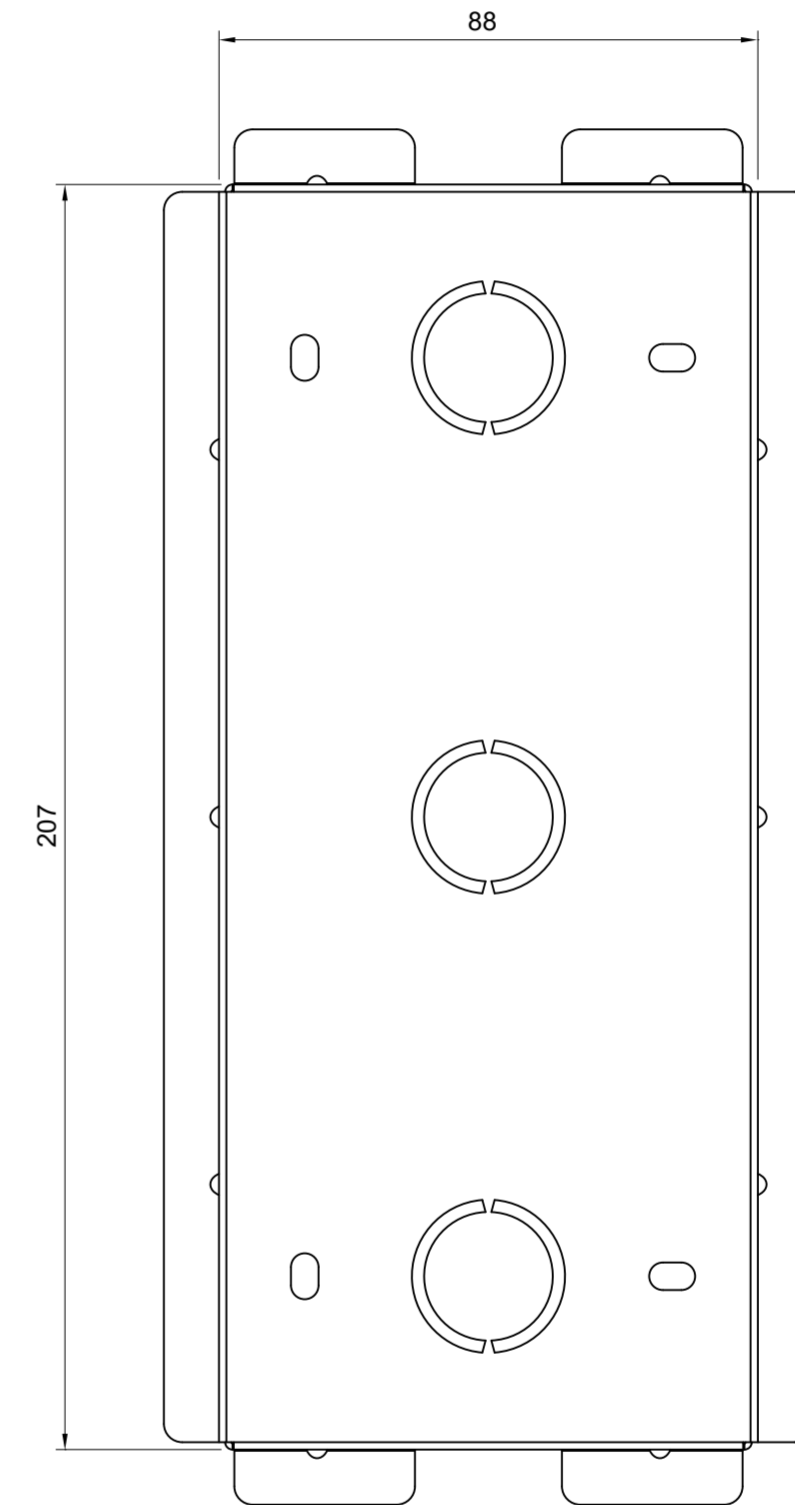

④ **BACK VIEW**

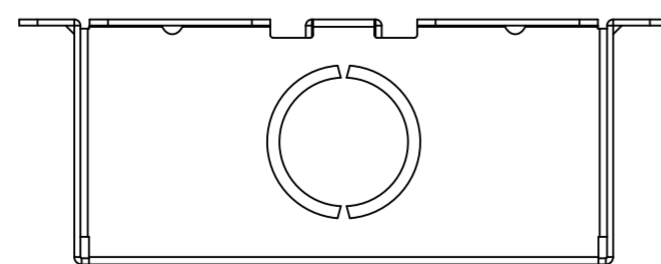

⑤ **TOP VIEW**

Applicable Model

R20K

Drawing Title

Placement

Drawing Unit

mm

Drawing Scale

Not to scale

**DRAFT
SUBJECT TO
CHANGE**

Last Revised

Oct 09,2023

Drawing Version

V1.0

Page

8 of 10

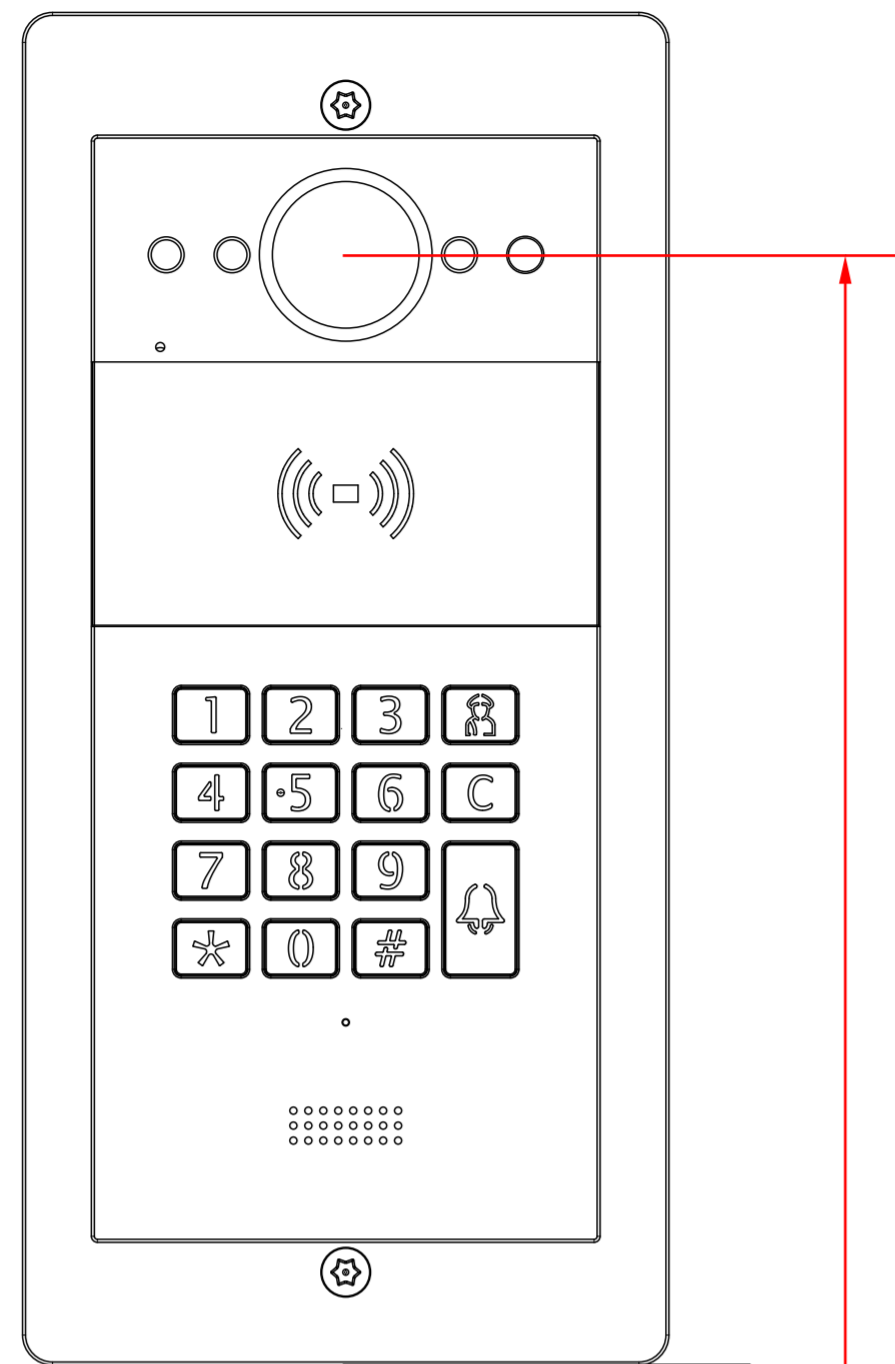

① INTERCOM PANEL FRONT VIEW

1214.5mm TO BOTTOM OF BRACKET

1400mm TO CENTER OF CAMERA

ADA Compliance Requirement

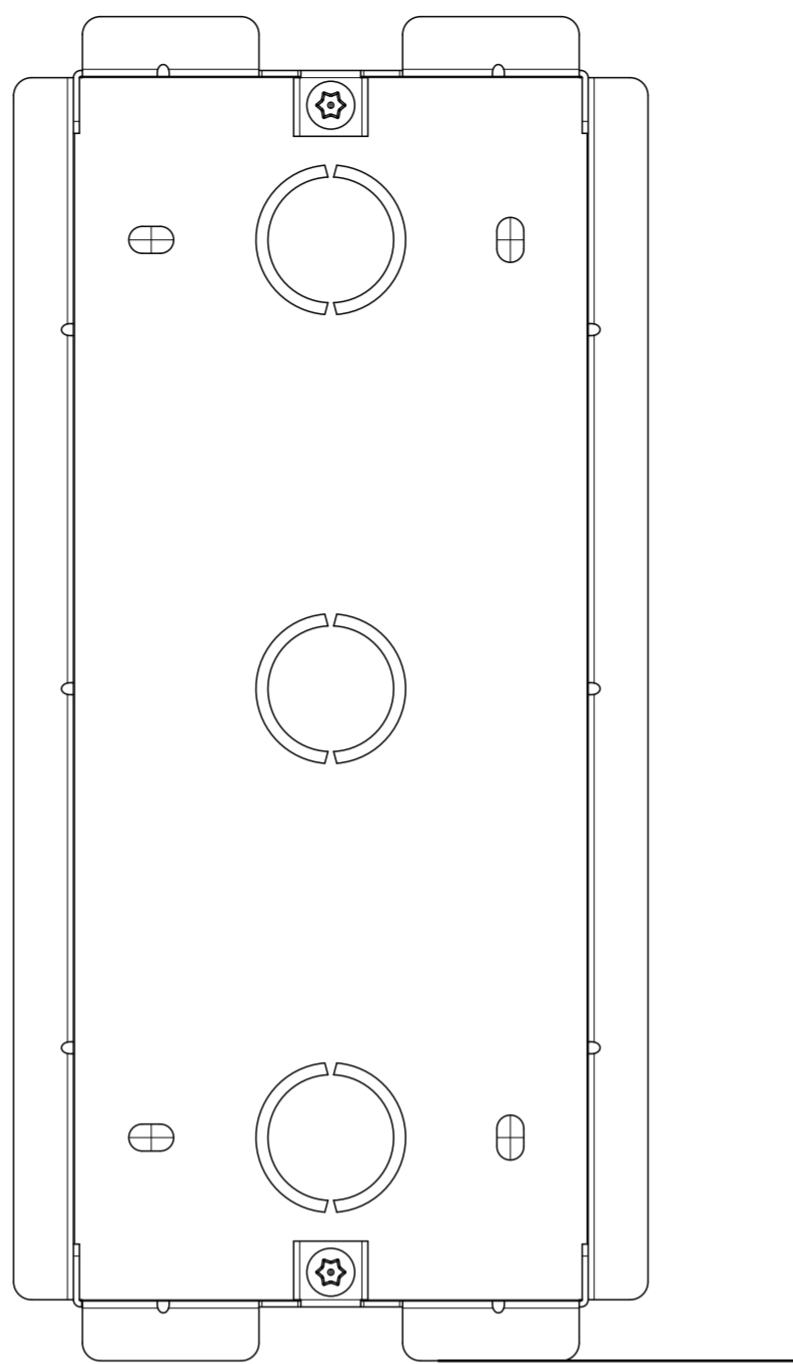
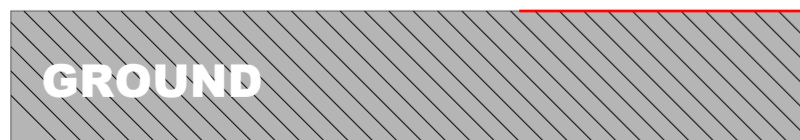

② FRONT VIEW: FLUSHING MOUNTING BOX PACEMENT

1215mm TO BOTTOM OF BRACKET

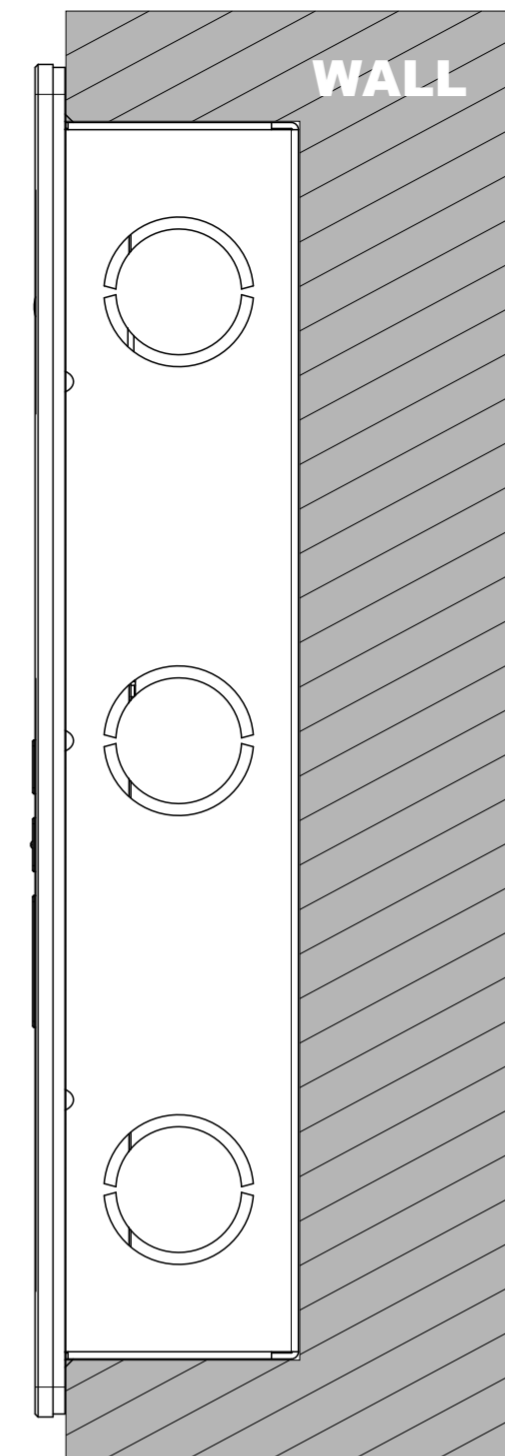

③ SIDE VIEW:INTERCOM PANEL IN WALL

Applicable Model

R20K

Drawing Title

In-Wall Mounting
Rain Cover

Drawing Unit

mm

Drawing Scale

Not to scale

**DRAFT
SUBJECT TO
CHANGE**

Last Revised

Oct 09, 2023

Drawing Version

V1.0

Page

9 of 10

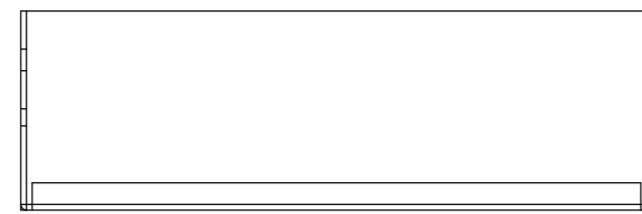

⑥ **BOTTOM VIEW**

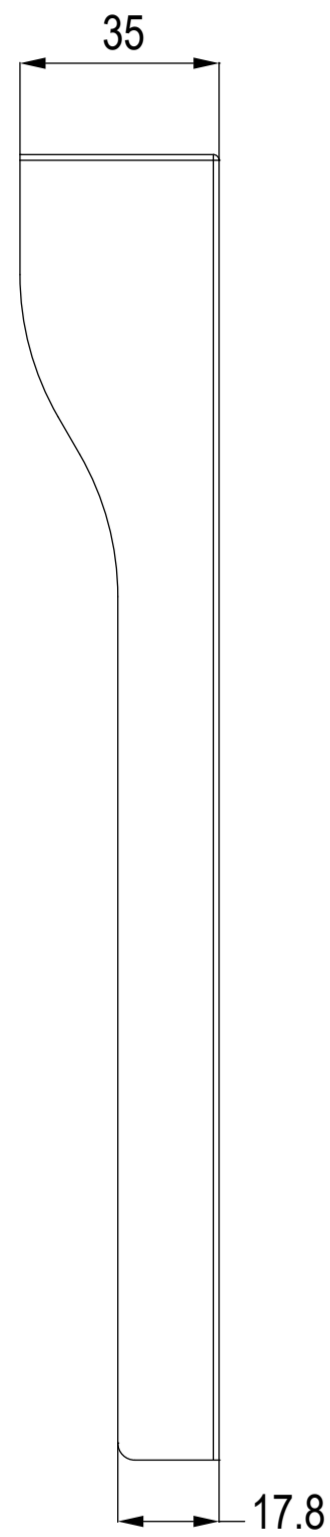

② **RIGHT VIEW**

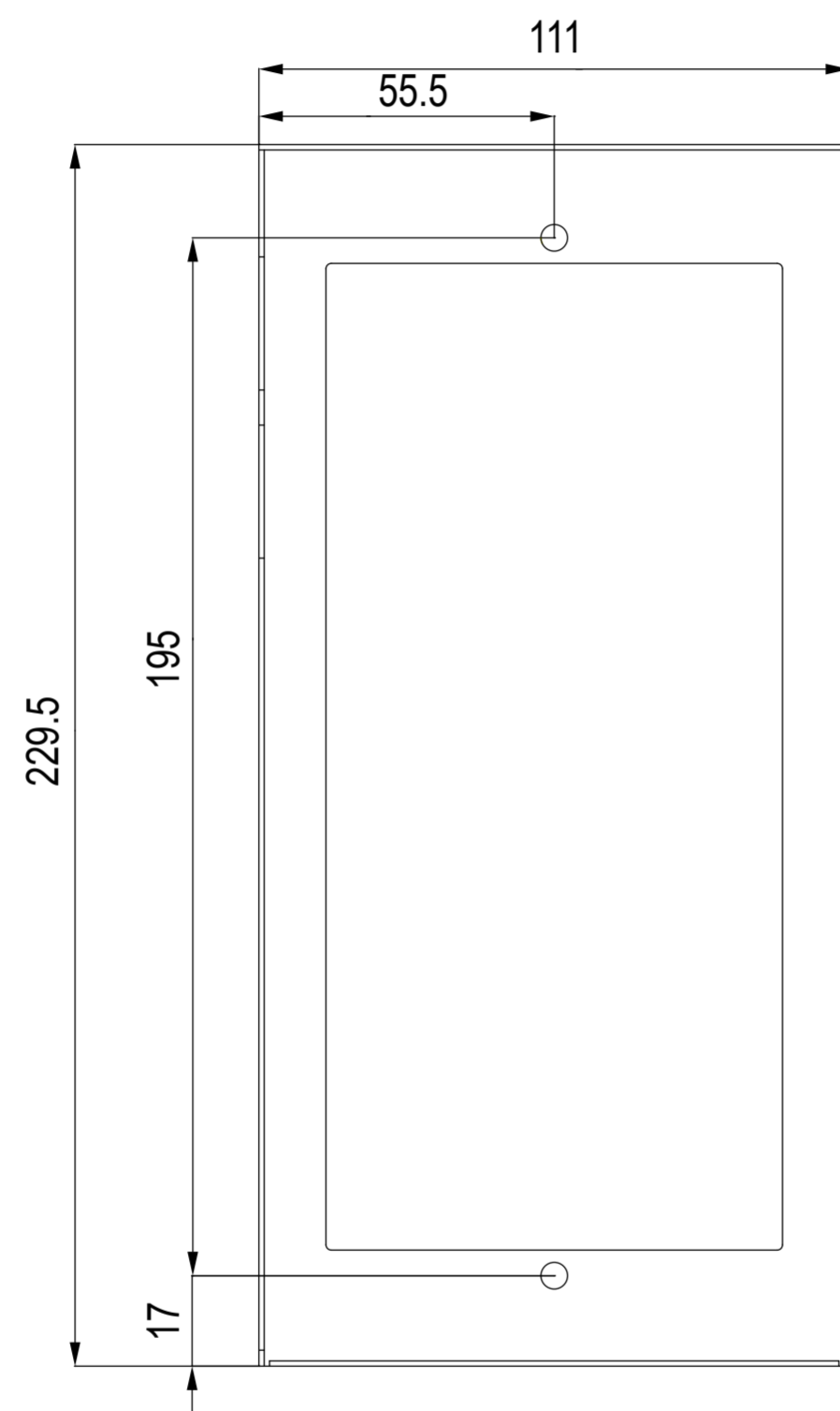

① **FRONT VIEW**

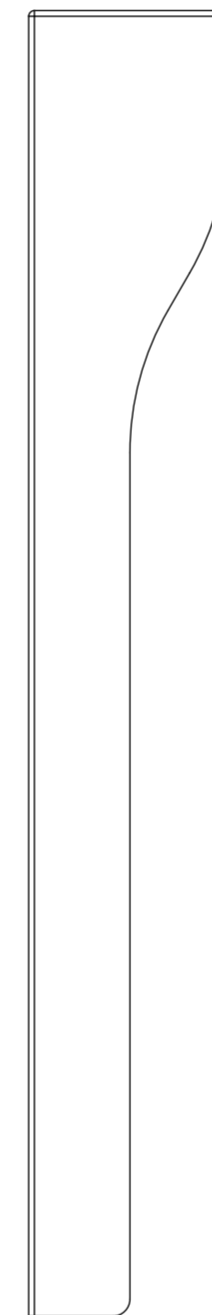

③ **LEFT VIEW**

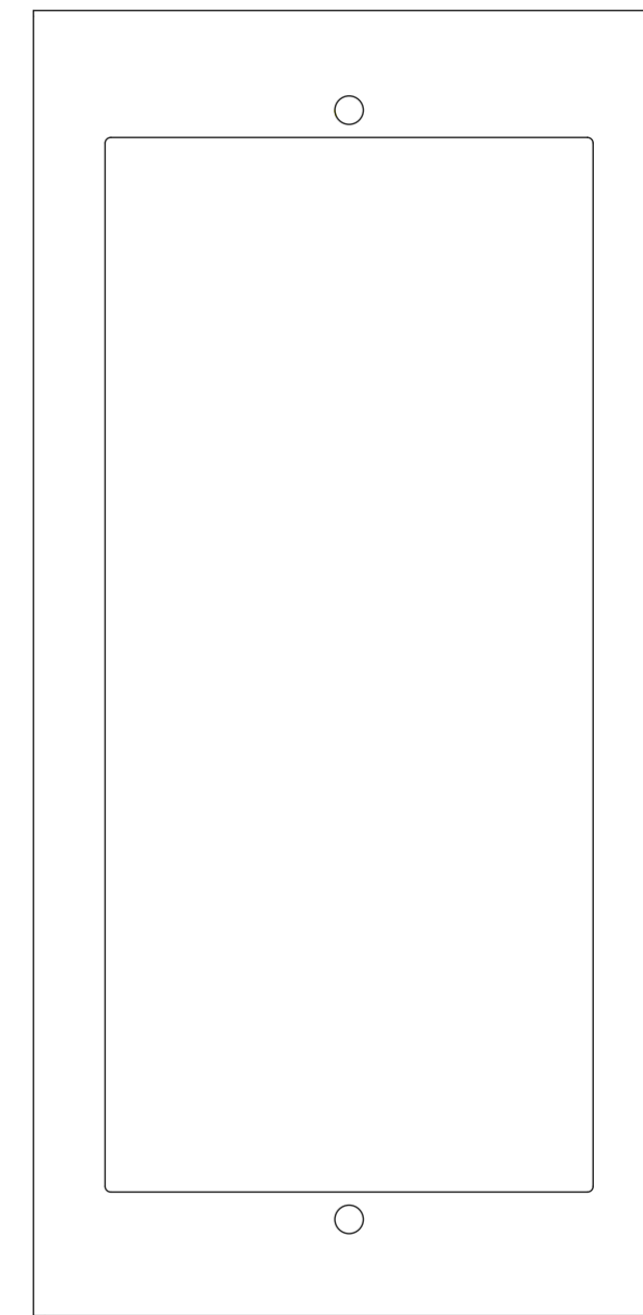

④ **BACK VIEW**

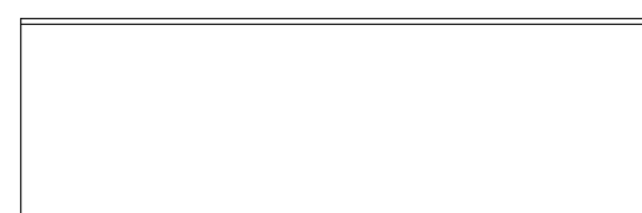

⑤ **TOP VIEW**

Applicable Model

R20K

Drawing Title

Placement

Drawing Unit

mm

Drawing Scale

Not to scale

**DRAFT
SUBJECT TO
CHANGE**

Last Revised

Oct 09,2023

Drawing Version

V1.0

Page

10 of 10

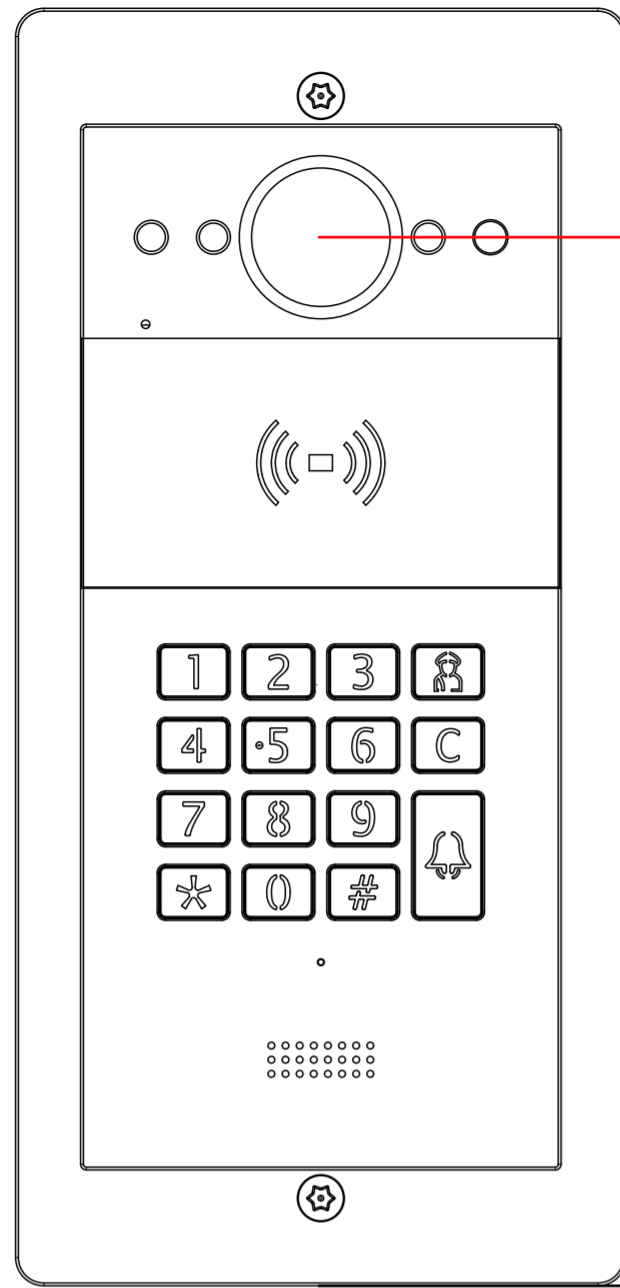

① INTERCOM PANEL FRONT VIEW

1214.5mm TO BOTTOM OF BRACKET

1400mm TO CENTER OF CAMERA

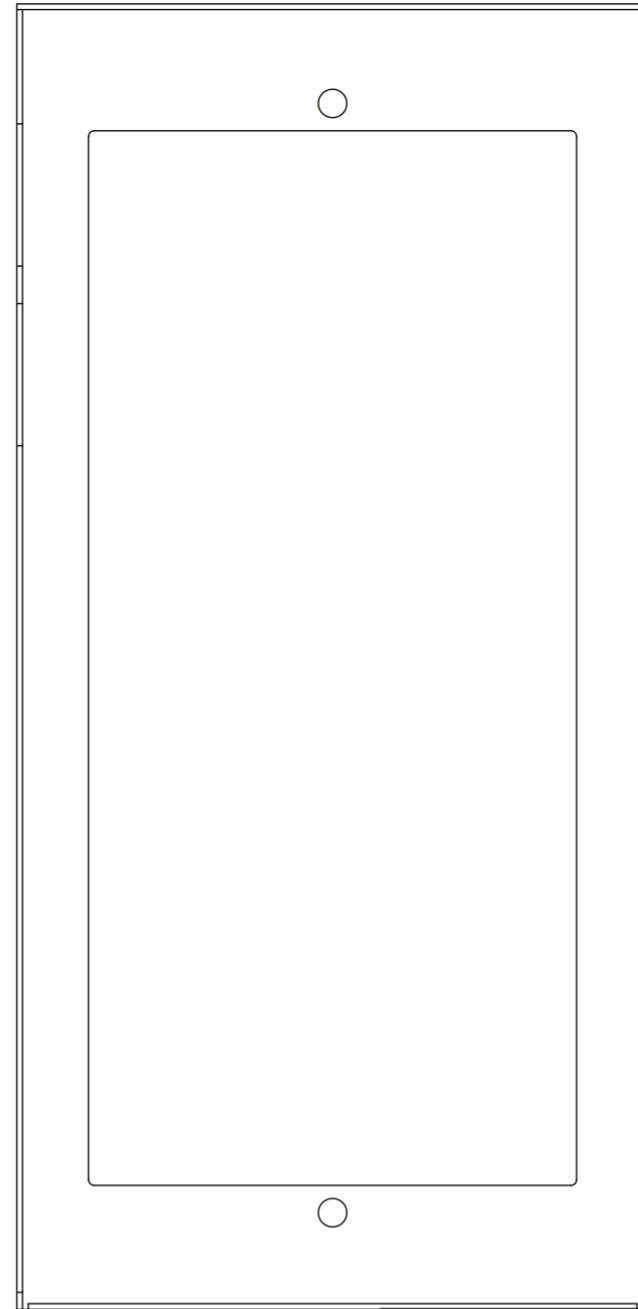

② FRONT VIEW:WALL MOUNTING BRACKET PLACEMENT

1213mm TO BOTTOM OF BRACKET

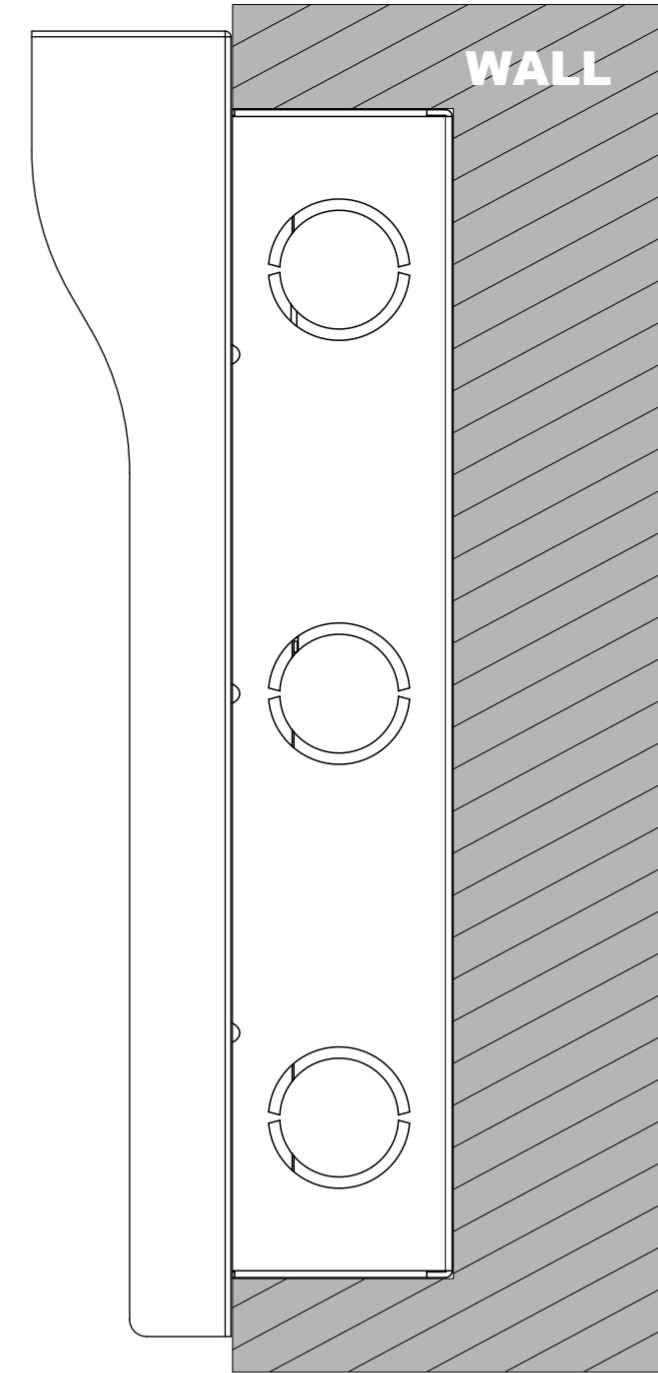

③ SIDE VIEW:INTERCOM PANEL IN WALL

ADA Compliance Requirement

GROUND

GROUND